

PRO SERIES IFLEX™

5-CHANNEL LIMITLESS SPECTRUM POSSIBILITIES WITH INDIVIDUAL
AND FULL CHANNEL FIXTURE DIMMING
USER GUIDE

URBARN







A BREED APART

URBARN® aligns with the spirit and drive of a farmer:

Relentless focus on operational efficiency and productivity backed by a community of like-minded business owners.

Table of contents:

Warranty

Safety & Precautions

System Hardware & Accessories

Assembly & Mounting Instructions

URBARN Light Fixture Bluetooth App

Technical Specifications

Warnings

Care & Maintenance

URBARN[®]
TOOLS TO **GROW** WITH



Warranty

Every URBARN® horticultural light is designed, engineered, and built by Abundant Lighting, LLC, in Grand Rapids, Michigan, USA. We use the finest materials from around the world to ensure you have the most advanced technology available. All URBARN® lighting products are guaranteed against manufacturing defects for five (5) years from date of purchase. For detailed warranty information, visit URBARN.com

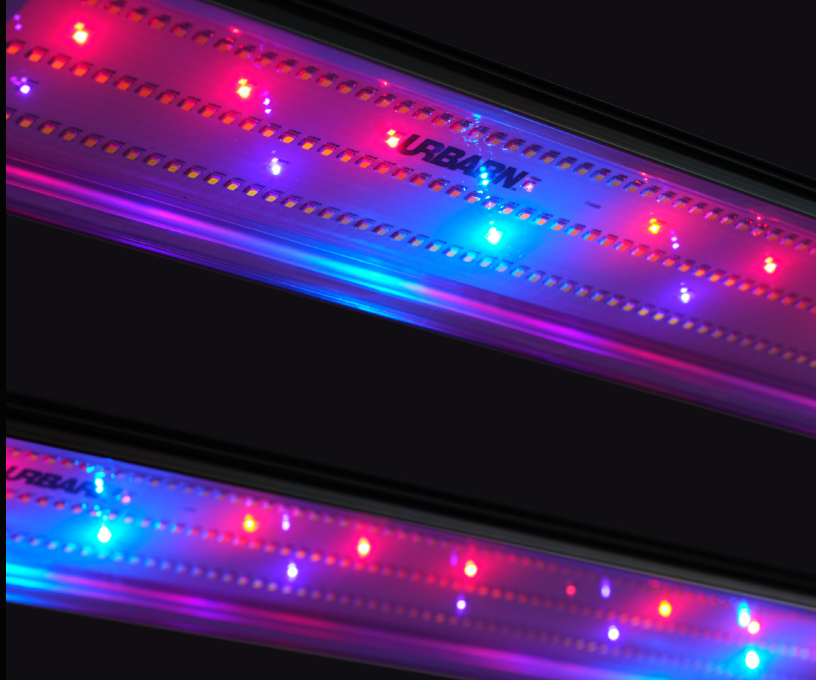

Safety & Precautions

Please read this manual thoroughly before attempting to install or operate your URBARN® horticultural light and keep it in a safe place for future reference. This fixture must be installed by a qualified electrician. It is important that you read, fully understand, and observe the subsequent safety precautions.

This fixture is suitable and rated for Damp and Dry locations. Care should be taken that it is used in a manner that does not exceed the power supply's rated ampacity or the maximum ambient temperature 40°C of its respective components in its installed environment. For longevity and peak performance, avoid exposure to direct sunlight as it may raise ambient temperatures past the fixture rating.

The URBARN luminaire should not be concealed or extended through a wall, floor, ceiling, or other parts of a building. It should not be located above a suspended ceiling or dropped ceiling and should not be permanently affixed to a building structure.

Care should be taken that the luminaire mounting components and wiring are not subject to strain and are protected from physical damage. When suspended, each luminaire should be visible over its entire length.

Connect your URBARN light fixture to power sources of the correct voltage. Protect power cables from being pinched, walked on, or otherwise damaged. The LED Driver is NOT a serviceable part. It must maintain its factory mounting to the fixture. Removal or loosening of any fixture hardware can cause serious personal injury or damage to the fixture.

DO NOT defeat the safety purpose of a grounding or polarized plug by removing ground pins or using unsafe adapters. A polarized plug has two blades—one wider than the other. A grounding plug has a third ground prong in addition to the two main conductors. The wide blade or third grounding prong is provided for your safety. If the provided plug does not fit your outlet, consult an electrician to replace your obsolete outlet. If you replace the power cord, only use one of similar type and equal or greater current rating.

The URBARN light fixture should only be cleaned as directed in the manual. You should seek service for your system by qualified factory support if any of the following occur:

- The power-supply cord or the plug has been damaged.
- The unit has been exposed to rain.
- The unit exhibits a marked change in performance.
- The unit has been dropped, or its enclosure or chassis is damaged.

The product must be installed in accordance with the National Electrical Code and all applicable local codes. Proper grounding is required for safety. The fixture must be installed in accordance with the applicable installation code by a person familiar with the construction and operation of the product and any hazards involved.

A

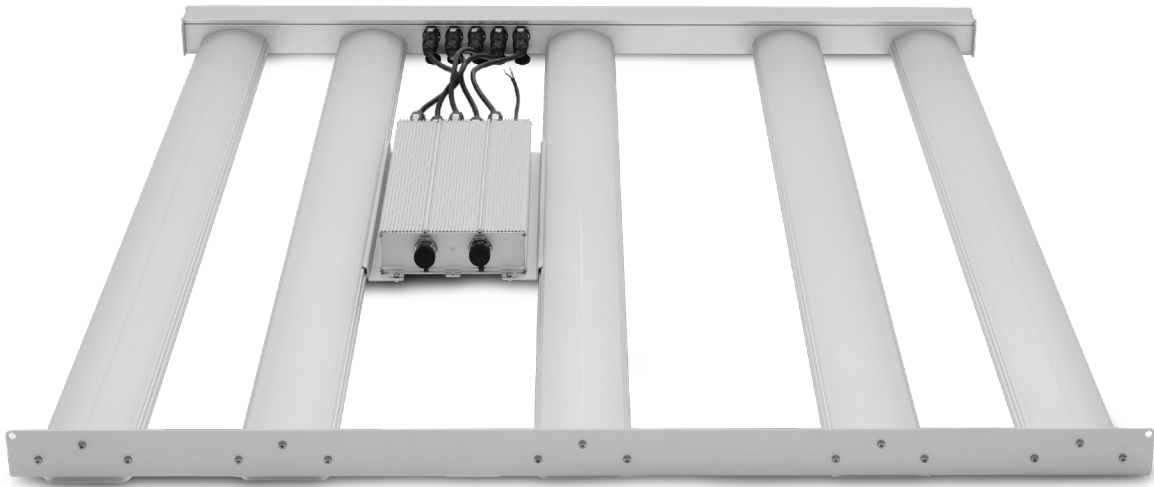

System Hardware & Accessories

System Hardware

A - URBARN® Pro Series iFlex fully assembled light

Accessories

B - AC Cables

- 8' AC Cable Only (included)
- 12' AC Cable Only (optional with incremental charge)
- NEMA Rated 5-20P 125V 20A (Plug Only)
- NEMA Rated 6-20P 250V 20A (Plug Only)
- NEMA Rated 7-20PL 277V 20A (Plug Only)

C - Jumper Cables (if ordered) 4' or 8'

D - Mounting Hardware

- D₁ - Galvanized Cable System - Paddle (standard)
- D₂ - Rope Ratchet (special order)

E - Reference

- User Guide



Assembly & Mounting Instructions

Remove light fixture and hardware from packaging. Be sure to place on a stable and flat surface with LEDs facing downward.

Adjust the cables or rope ratchets fixture connections to their desired position and secure. Be sure that the connection points to the lighting fixture are spaced an equal distance from the endcaps to ensure fixture stability.

Maintain a minimum of 12" distance from ceilings. Care should be taken to never mount any electrical lighting fixture near highly combustible materials. Check local building codes for more specific instruction if required.

If layout of facility calls for multiple fixtures to be powered with jumper cables, attach female connector to male connector on drivers.

Cable System

Secure the hanger cable to an overhead supporting structure using a minimum of two hanger points.

- Option 1: Secure the loop portion of the cable to a beam mount or similar secure hanging point.
- Option 2: Pass loop side of the cable over, around and under structure capable of supporting 40 pounds or more. Then pass straight end of cable through loop and pull tight.
- Repeat for both sides and ensure mounting position is equal distance from ends to maintain balanced system.
- Raise fixture with "Y" toggle and grippers to the loop cable secured to structure above. Pass the straight end of loop cable through the toggle. The plunger on top of the toggle catches and holds the cable securely.
- Level the fixture plumb with the building lines to the desired height over the plant canopy (to let out cable, push the plunger down).

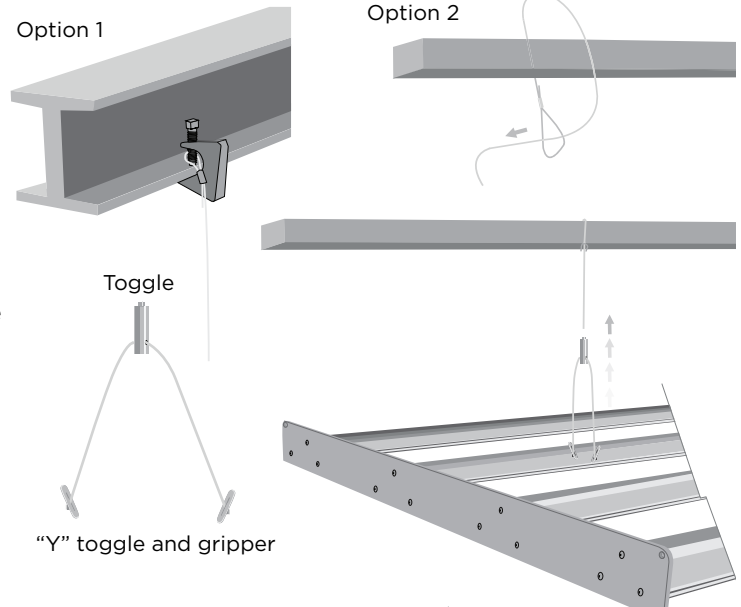

Adjustable Loop with Rope Ratchet

Fasten the adjustable rope clip hangers (provided) to light's mounting holes. Repeat for both sides to ensure mounting position is equal distance from ends to maintain a balanced system.

- Attach the carabiner clip on the ratchet to a secure overhead hanging location such as a threaded hook or anchor.
- Secure the carabiner clip on the end of the looped rope to the fixture. Make sure not to exceed 75 pounds per ratchet.
- Tighten the ratchet by pulling the loose end of the rope to raise the fixture to the desired height.
- To loosen or lower the attached light, depress the small lever recessed within the rope ratchet. Replace rope when worn.

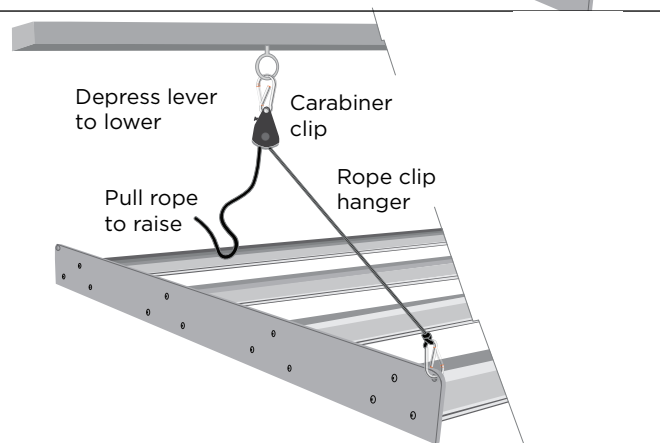

Final Adjustments

Hang the fixture in the desired location and adjust the mounting height to six inches from canopy. To prevent the overheating of lighting equipment or combustible materials within the installation environment, please maintain at least 12" of open-air space above the unit. Once the fixture is in place, plug the AC cable into the wall or ceiling outlet. Make sure no one is looking directly at LEDs when power is connected.

Note: This URBARN® light fixture is suitable for Dry and Damp location installation. The fixture is not for intra-canopy use.

WARNING: Carefully inspect the connections before hanging the cable system or rope ratchet.

DO NOT EXCEED LOAD LIMITS:

- CABLE KIT - 40 pounds per cable. Inspect each cable before using.
- ROPE RATCHET (special order) - 75 pounds per ratchet. Inspect each ratchet before using.

DO NOT USE IF DAMAGED. Avoid hot surfaces, sharp edges, abrasive surfaces and pinch points.

Setup & Usage of the URBARN™ Light Fixture Bluetooth® App

This URBARN™ horticultural lighting fixture uses an advanced low energy Bluetooth® application to control all facets of its operation. The URBARN app can be found and downloaded for either iOS or Android Bluetooth-equipped phones from their respective app stores.

Initial Download Procedure

- After downloading the URBARN app, you will be greeted by a welcome screen. Click “Start” to begin the setup process.
- You will be prompted to sign into an URBARN account.
- If you’ve created an account previously, enter your email address and password, and you will be launched directly into the application.
- If this is your first time, click “Create an account” or log in using one of the available providers.
- You will be prompted with Terms & Conditions.

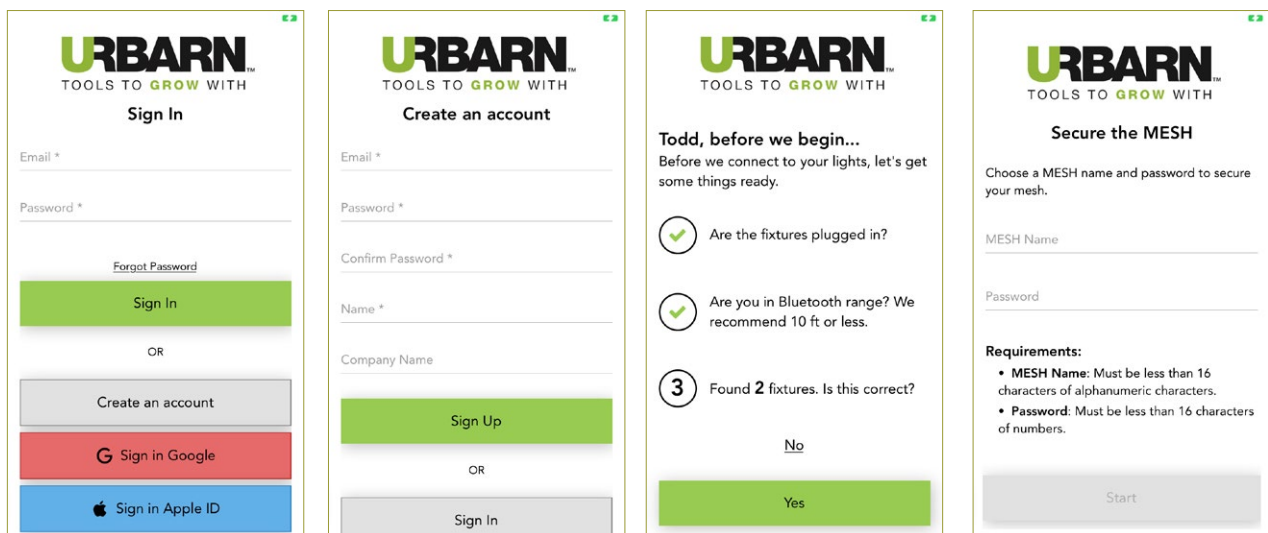

Setting up Your Mesh Security Settings

- Click “Continue” to setup up your mesh security settings.
- The app will guide you through the set up process by first scanning for available URBARN lights.
 - Accept the prompt to use Bluetooth.
 - On Android, location permissions are required to use Bluetooth. (Note: URBARN does not store or use your location in any way.)
- Make sure your lights are powered on and you are in Bluetooth proximity. We recommend 10 feet or less.
- Once the scan is complete, click “Yes” if the app found all of your available fixtures. Click “No” to start over.
- Clicking “Yes” will bring you to a screen to set a mesh username and password. These security settings ensure your lights can only be controlled by users with the correct username and password.
- Once you’ve met the requirements, click “Start” to apply the security settings to the lights. The lights will blink blue when they have successfully received the new security configuration.
- Once the setup is complete, click “Finish” to enter the main application screen.

Operating Your URBARN™ Light

The main application screen allows you to scan for lights in your mesh. Be sure the lights are powered on and you are in Bluetooth proximity to at least one light.

- To control any light, click on the light and adjust light-specific settings.
- Click and hold the light to view additional functions.
- If you do not see lights, click the “Scan” button to search for mesh lights.
- Click the three bars in the top left corner to open the main application menu and browse to other screens.

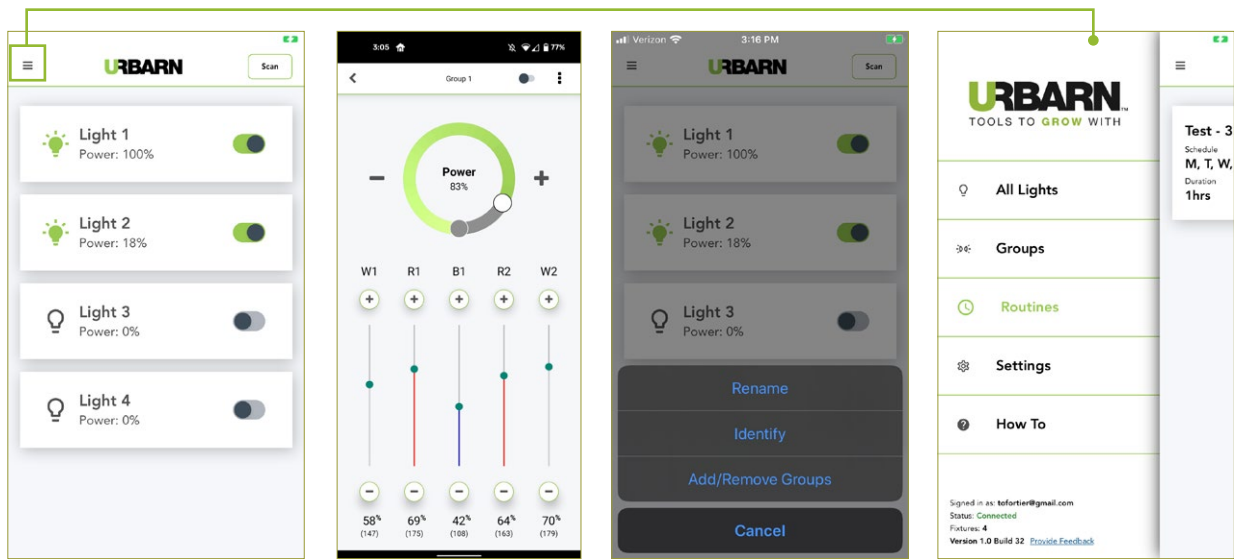

The beauty of URBARN?
You decide. Tweak the number of lights,
placement, cycles and run times through
the app—do what works based on the
needs of your plants. We’re here to
facilitate and offer advice, but ultimately
you’re at the wheel to drive results.

Groups

The Group screen allows you to control sets of lights called “Groups.”

Note: You must be connected to the mesh to create and control Groups.

- To create a new Group, click “New Group” in the top right corner.
- Click on the Group to control its settings.
- To add lights to the Group, click on the three dots in the top right corner.
- Select the light(s) you would like to associate with the Group.
- The light(s) will blink blue to indicate acceptance of the Group assignment.
- Return to the main screen to control the Group.

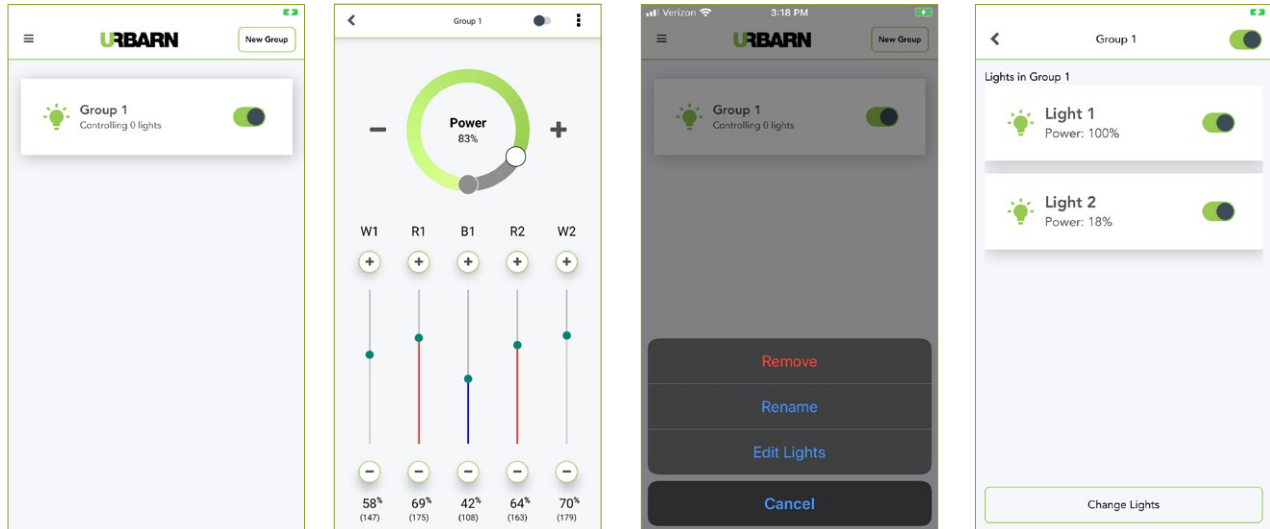

Routines

The Routines screen allows you to schedule times when the light will be on or off. Note: You must be connected to the mesh to create and modify Routines.

- Click “New Routine” in the top right corner to create a new Routine.
- Enter a name for the Routine.
- By providing an expiration date, you will be notified when a Routine should expire. It does not automatically cancel the Routine. You will need to reconnect to the mesh to manually delete the Routine.
- Enter a time when the light or Group should turn on.
- Select how many hours the light or Group should remain on.
- Select on what days the Routine should execute.
- Select what target light(s) or Group(s) should execute the Routine.
- Click the check mark in the top right corner to save the Routine.
- Confirm the Routine’s settings.
- The light(s) or Group(s) will flash blue to indicate acceptance of the new Routine.

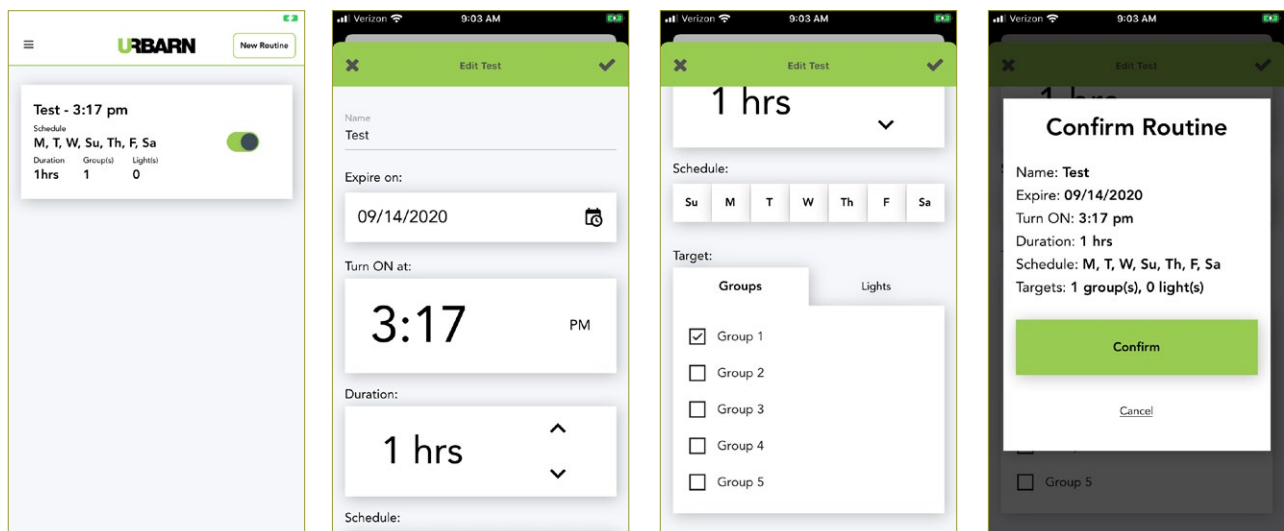

Settings

The Settings screen allows you to perform additional functions such as recover your settings or add new lights. You can also visit the website or contact support if you are experiencing issues with the lights or app.

- Click the “Recover MESH” button to re-download a copy of your mesh security settings.
- Click “Share MESH” to invite a user to use your mesh security settings. Invitees will receive two emails: one to download the app and another to accept the mesh settings. Users must first download the app and create an account to accept a mesh invite.
- Click “Add Lights” to add new lights to your mesh. Lights must be turned on and in Bluetooth proximity to be added to the mesh.
- Click “Sign Out” to return to the main login screen.

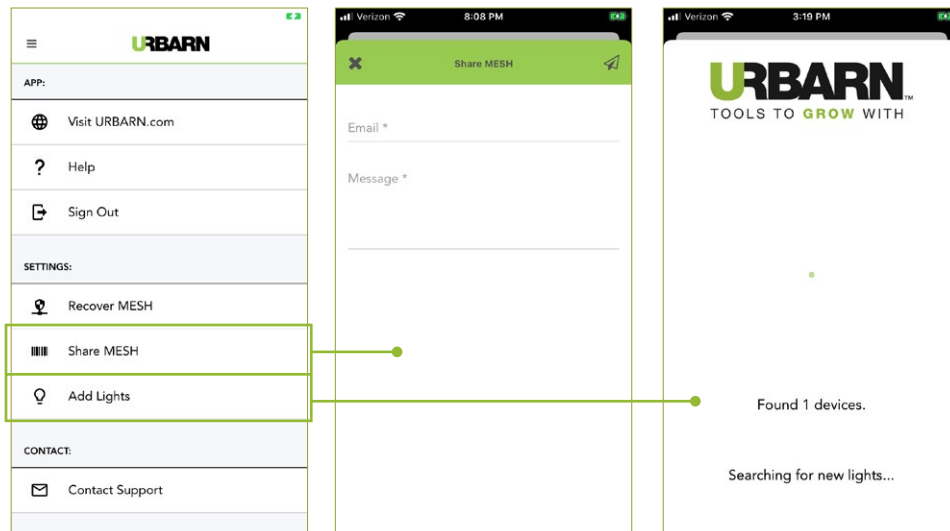

Feedback

The Feedback screen allows you to submit inquiries and ideas to URBARN™ on how to improve the app. We welcome your input.

- Click on the three lines in the top left corner to open the menu.
- On the bottom of the menu, click “Provide Feedback.”
- Complete the form and click the send button in the top right corner.

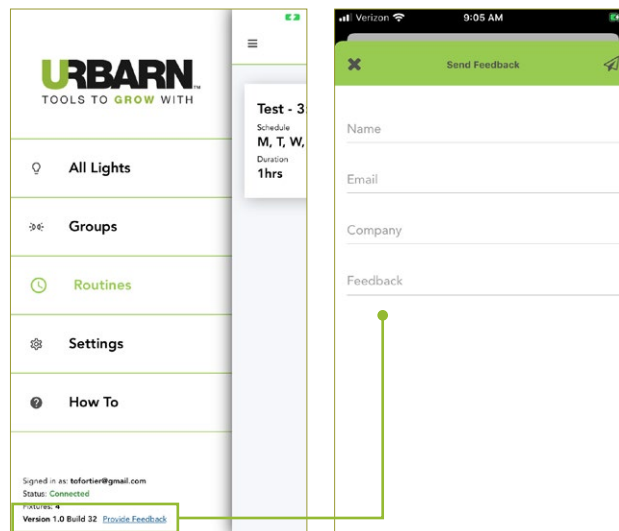

Technical Specifications



Family/Model

URBARN® Garden Grid (Red Grow/Bloom)

Spectrum

Grower adjusted

Input Voltage

220-480VAC

AC Power Cord

8' (standard), 12' (special order)

AC Plug

NEMA Rated 5-20P Plug

NEMA Rated 6-20P Plug

NEMA Rated L7-20P Plug

Mounting Hardware

Finished Galvanized Cable System (standard)

Rope Ratchet (special order)

Packaging

Single Unit (1)

Driver Input Frequency:

50/60Hz

Max Fixture Ambient Temperature:

40°C

Max Driver Ambient Temperature:

50°C

Photosynthetic Photon Flux (PPF)

1825 μ mol/sec

Energy Efficiency (PPE)

2.30 μ mol/sec

Nominal AC Input	220V	480V
AC Current (Amps)	3.20	1.57
AC Input Power (Watts)	865	782

WARNING

Risk of electrical shock. To reduce the possibility of serious injury, always take the proper precautions and unplug the fixture before moving or cleaning.

CAUTION

LED and heatsink surfaces may be hot. Allow sufficient cooling time before handling. To prevent eye damage, avoid looking directly at the unshielded LEDs.

To reduce the risk of overheating or fire, never place operating fixtures face down on a flush surface. Always allow for adequate ventilation of fixtures and power supplies.

WARNING - POSSIBLE RISK OF INJURY TO EYES AND SKIN

RISK GROUP 1 Hazardous optical radiation may be emitted from the light source. Do not stare at operating lamp. May be harmful to eyes. GROUPE DE RISQUE 1AVIS UV émis par ce produit. Minimiser l'exposition des yeux.

UV may be emitted from the light source. Eye or skin irritation may result from exposure. Use appropriate shielding.

IR may be emitted from the light source. Do not stare at operating lamp.

Care & Maintenance

- Your URBARN® horticultural light uses passive cooling. The light is designed for indoor use and the unique conditions found in plant grow facilities. Some basic care will keep your light operating at peak performance.
- For your light to properly cool itself, we recommend at least 152mm (6 inches) of space between the fixture and the ceiling of your grow facility. Failure could result in shortened lifespan.
- To optimize lifespan and performance, we recommend checking for and removing excess dust, debris, and mineral build up from the fixture and glass.
- Cleaning should always be done with the fixture unplugged from its power source. We recommend using lowpressure compressed air or water to rinse away dust.
- Water should never be applied directly to the board surface on which the LEDs are mounted.

PLEASE NOTE:

The light source of this luminaire is not replaceable; when the light source reaches its end of life, the whole luminaire shall be replaced.

Horticulture lighting is not suitable for household room illumination.



URBARN®

URBARN®

URBARN



LEARN MORE at urbarn.com

and let us know how we can help you grow

866.333.1659 | 3529 3 Mile Road NW, Grand Rapids, MI 49534



3529 3 Mile Road NW, Grand Rapids, MI 49534
866.333.1659 • urbarn.com

URBARN
TOOLS TO **GROW** WITH

